

PVC-ikkunat ja -parvekeovet

Saranapuoli K

Yläsarana

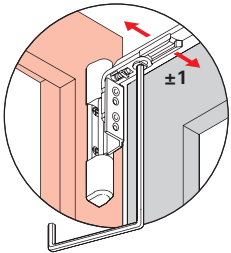
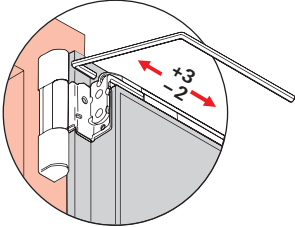

Alasarana

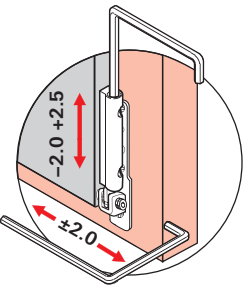

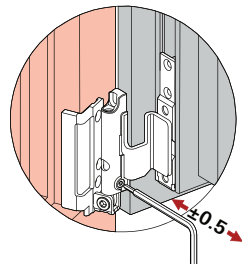
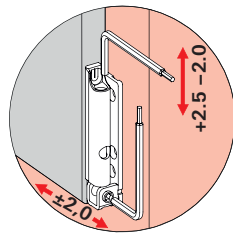
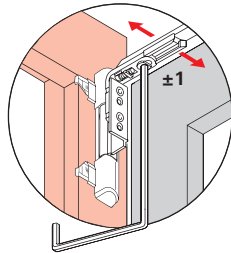
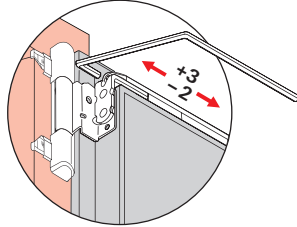

Saranapuoli A *



* Esitetyt säätömitat muuttuvat käytettäessä ylä- ja alasaranoiden koristehattuja.

Säätötyökalut

Kuva	Kuvaus	Materiaalinro
	4 mm kuusiokoloavain	208 609
	2.5 mm & 4 mm kuusiokoloavain	230 764

Roto Frank AG
Ikkuna- ja ovitekhnologia

Wilhelm-Frank-Platz 1
70771 Leinfelden-Echterdingen
Puhelin +49 711 7598-0 • Telefax +49 711 7598-253
info@roto-frank.com • www.roto-frank.com

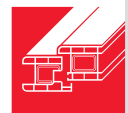

Telki E

Säätötyökalu Säätöalue asteina ° Tiivistepaineen säätö / mm

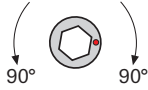

+/- 0.8

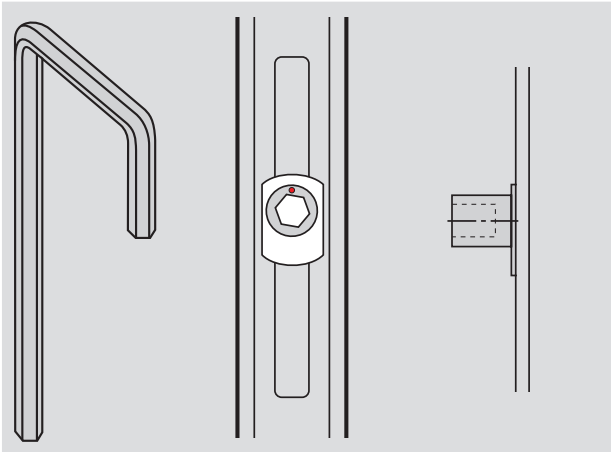

Telki P

Säätötyökalu Säätöalue asteina ° Tiivistepaineen säätö / mm

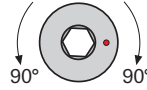

+/- 0.8

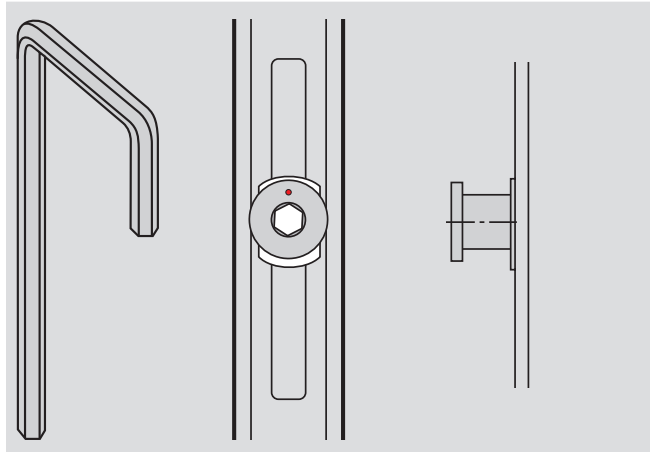

Telki V

Säätötyökalu Säätöalue asteina ° Tiivistepaineen säätö / mm Korkeuden säätö / mm

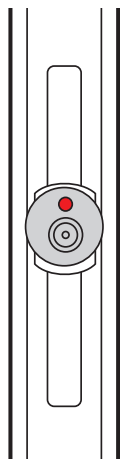
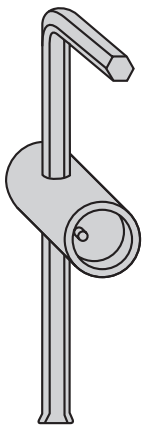

0 = Alkuasento

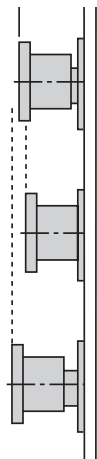

Säätöalue asteina ° Tiivistepaineen säätö / mm

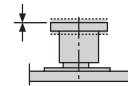

-

-

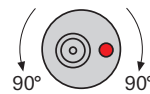

+/- 0.8

+/- 0.2



-

+/- 0.4

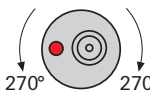

+/- 0.8

+/- 0.6



-

+/- 0.8

